

# »» COBRASlim

Operations Manual  
Rev 3.0 [CN0468]  
24 October 2014



Table of Contents .....	2
Photobiological Safety .....	3
Safety Message .....	3
Warning stickers .....	3
Power Supplies and Cables .....	4
Choosing the Correct ProPhotonix Power Supply .....	4
DIN Rail Mounting of Power Supplies .....	4
Connecting the Wall Plug Leads to the Power Supplies .....	4
Power Up Procedure .....	5
Overview of Connection Schemes .....	5
Diagrams of COBRA Slim Connection without External Controller .....	5
Pin-out on 2-core COBRA Slim Cable for Use without ECU .....	5
External Control .....	6
COBRA Slim Connector Pin-Out and Functionality .....	6
Ethernet Control .....	6
Optical Performance Characteristics .....	7
Relative Intensity & Line Width vs. Working Distance .....	8
60°x10° Diffuser: (Backlight) .....	8
Mechanical Dimensions and Mounting .....	9
LED Lifetime .....	10
Cleaning or Replacing Fans .....	10
Cleaning or Replacing Lens, Optical Windows .....	10
Warranty .....	10
Ordering and Part Numbers .....	10
Part Number Structure .....	10
Part Number Options .....	11
Power Supply Part Numbers .....	11
Plug Type Part Numbers .....	11
COBRA Slim Accessory Part Numbers .....	11

## Photobiological Safety

The following message to our clients is required by IEC photobiological safety standards for LED sources.

Important Safety Message for COBRA Slim Illuminator users:

The COBRA Slim Illuminator is a LED-based radiation source, intended for use as an OEM component. It must be used only inside a system such as, for example, a machine vision system, and must never be used as a stand-alone product outside of the intended machine vision system.

Until further notice from ProPhotonix, you must consider that your COBRA Slim device is classified in Class 4 LED product according the IEC standard mentioned above.

For COBRA Slims emitting at UVA:

WARNING: This product emits ultraviolet radiation. Do not under any circumstances look at or allow your skin to come into contact with the ultraviolet radiation. Your eyes or skin may be damaged.

Certain medications and chemicals can increase an individual's sensitivity to UV radiation. Consult your physician for specific information.

These lamps are not intended for, and should not be used for, diagnostic, therapeutic, or cosmetic purposes.

When handling the 380 or 395-nm-emitting COBRA Slims, wear gloves, garments with sleeves, and wear glasses that have an optical density (OD) equal to 3.

For all COBRA Slim wavelengths:

WARNING: Do not look at exposed lamp in operation. Eye injury can result.

## Warning Stickers

Below are the contents of warning stickers that are affixed to COBRA Slim Linescan Illuminator devices.

UVA

WARNING: Visible and invisible radiation is emitted through the window on the device. Skin or eye damage could result. Avoid exposure of eyes and skin to unshielded lamp.

Visible Wavelengths

WARNING: Do not look at exposed lamp in operation. Eye injury could result.

IR

WARNING: Invisible radiation is emitted from window on device. Do not look at exposed lamp in operation. Eye injury could result.

## Power Supplies and Cables

All wall plugs are available. These include US/Japan, UK/Singapore/Malaysia, Europe, Israel, etc. See section below on ordering and part numbers.

Please Note: In the event of ESD or EFT, the unit or sections of the unit may temporarily turn off, but will turn back on again resuming normal operation without manual intervention.

### Choosing the Correct ProPhotonix Power Supply

ProPhotonix recommends the use of the designated 24V  $\pm$  10% power supply, which is a standard COBRA Slim accessory. Since the current regulation function is incorporated within the COBRA Slim units, there is no need for COBRA Slim users to purchase power supplies any more elaborate than those offered by ProPhotonix. The part numbers and dimensions are as follows:



ProPhotonix Power Supply	Rated Wattage	Physical Dimensions
PSU-24V-240W-xx	240W	125.5mm Width x 100mm Depth x 125.2mm Height

To determine the appropriate power supply, refer to the table of DC electrical power requirements in the section entitled "Nominal Electrical and Optical Specifications", and calculate the total power required.

When using PSU-24V-240W-xx, you may connect up to 8 COBRA Slim Illuminators in parallel to a single 24V  $\pm$  10% power supply, depending on cooling option. Refer to page 7 of datasheet for further details.

COBRA Type	Power Rating	COBRA Per Power Supply
COBRA TIL, TAL, TEL	48W	5 Max
COBRA CIL, CAL, CEL	25W	8 Max

Please note that the required Power rating appearing in the table of DC Electrical Power Requirements is the power required in order to deal with the initial power surge that occurs when the COBRA Slim is first powered up.

### DIN Rail Mounting for Power Supplies

The PSU-24V-240W-xx is supplied with hardware for mounting on DIN rail TS35/7.5 or 15.

### Connecting the Wall Plug Leads to the Power Supplies

The power supply cable leads must be connected to the 3-pole screw terminal block on the power supply. Use a Philips or Pozi head screwdriver. The correct connections are shown in the tables below.

North America / Japan

Colour	Function	Label on PSU
Black	Live	L
White	Neutral	N
Green	GND	

United Kingdom / Singapore / Malaysia / Europe / Israel

Colour	Function	Label on PSU
Brown	Live	L
Blue	Neutral	N
Yellow / Green	GND	

## Power Up Procedure

All wiring and connections must be implemented before plugging the power supply into the wall.

## Overview of Connection Schemes

### COBRA Slim Connection Without External Controller

When COBRA Slims are used without external control, the current supplied to the LED circuits from a power supply, via the included COBRA power cable part number C2-CAB-P-S-0200 is held constant, and optical intensity is therefore non-adjustable.



### Powercable connection

#### Pin-out on COBRA Slim Cable

Wire Colour	Power Supply Connection
Black	GND (-V)
Red	24V $\pm$ 10%

## External Control

### COBRA Slim Connector Pin-Out and Functionality

#### 1. Analogue Intensity Control

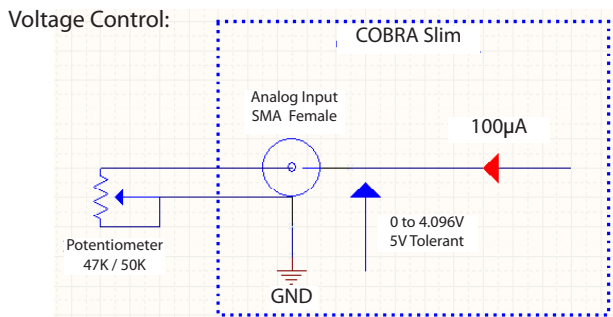
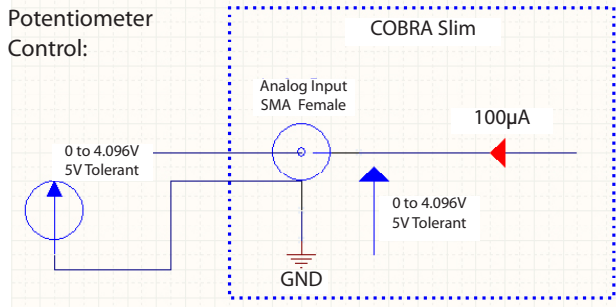

#### 2. Error Output

- Error Output:

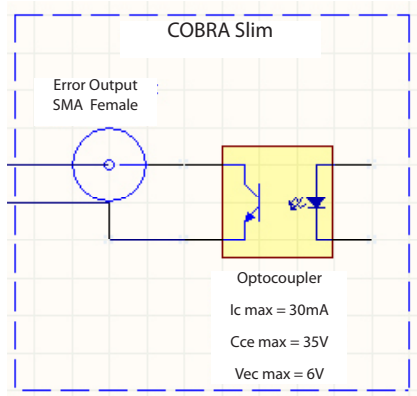

#### 3. Strobe Control

5V pulse:

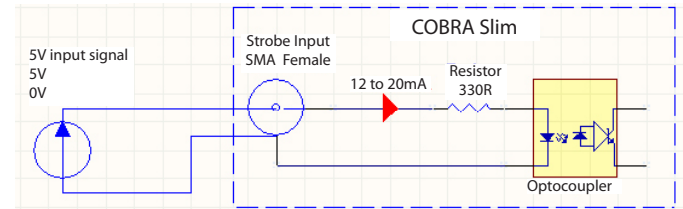

Pulse > 5V:

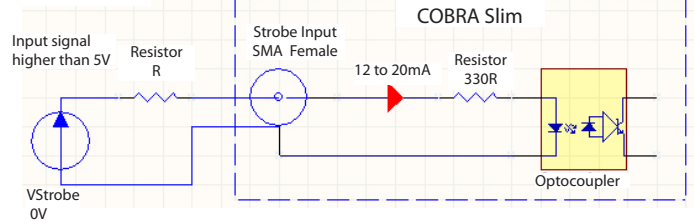

$$R = \frac{VPulse - 1.65}{10e^{-3}} - 330$$

Input Pulse Voltage (V)	R (Ohm)	Input Pulse Current (mA)
5V	0	~12mA
10V	470	~12mA
12V	680	~12mA
15V	1k	~12mA
24V	1.8k	~12mA

\* The Analogue Control pin is 5V compatible; however the maximum intensity is reached with a 4.096V input voltage.

## Ethernet Control

A COBRA Slim can be ordered with Ethernet connectivity as an option. This allows users to adjust the optical intensity and to diagnose the COBRA Slims over a network. Also, the optical intensity can be saved into the Ethernet Controller to allow the system to work without a computer connection.

Note: For extended line lengths incorporating more than one COBRA Slim module, only one Ethernet control module is needed.



## Spectral Characteristics

Colour		UV <sub>365</sub>	UV <sub>395</sub>	Blue <sub>470</sub>	RED <sub>630</sub>	IR <sub>870</sub>	IR <sub>1050</sub>	WHITE
Peak Wavelength <sup>(1)</sup>	nm	365±5	395±5	470±10	625±5	870±10	1050±20	n/a
Spectral Width FWHM	nm	12	14	27	15	47	75	n/a
Colour Temperature	K	n/a	n/a	n/a	n/a	n/a	n/a	5000-6000

(1) Nominal wavelengths and tolerance include thermal shifting

### Spectral Distribution

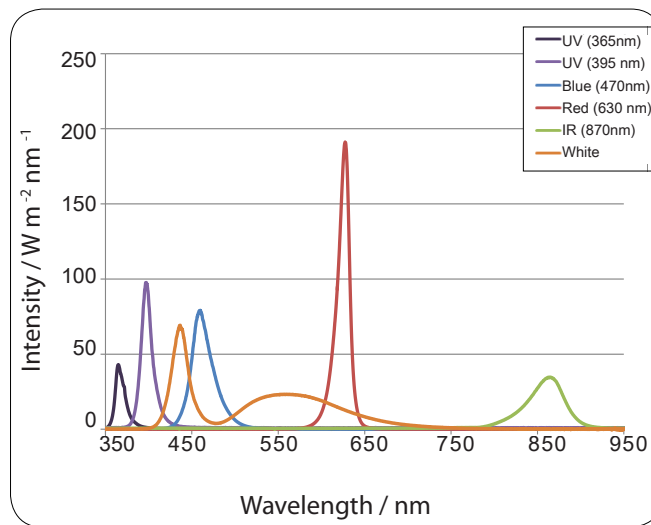

## Maximum Irradiance & Illuminance (Measured in S9 For 300 mm Units)

		UV <sub>365</sub>	UV <sub>395</sub>	Blue <sub>470</sub>	RED <sub>630</sub>	IR <sub>870</sub>	IR <sub>1050</sub>	WHITE
Convection Cooled								
Irradiance	$Wm^{-2}$	290	696	1353	1164	1024	923	3068
Illuminance	kLux	n/a	n/a	87	273	n/a	n/a	853
Fan Cooled								
Irradiance	$Wm^{-2}$	805	2320	3200	3520	2275	2250	5396
Illuminance	kLux	n/a	n/a	206	826	n/a	n/a	1500

## Focus & Illumination Field - White COBRA Slim

Lens Position <sup>3</sup>	Working Distance (WD) for Range Illuminance <sup>(4)</sup> (mm)		Working Distance at Peak Intensity (mm)		Line Width (FWHM) at WD (mm)		Focal Distance (mm)	Line Width at Focal Distance (mm) <sup>5</sup>
	100mm	300mm	100mm	300mm	100mm	300mm		
S1	10-53	10-105	divergent	divergent	14.0-15.6	14.0-19.4	divergent	divergent
S2	10-61	10-112	divergent	divergent	12.8-13.8	12.8-16.5	divergent	divergent
S3	10-68	10-132	collimated	collimated	11.0-12.5	11.0-13.1	collimated	collimated
S4	10-85	10-150	10	10	8.7-11.5	8.7-11.5	88	8.7
S5	10-103	10-142	10	10	6.6-10.8	6.6-10.8	88	6.6
S6	10-108	10-130	10	10	5.4-9.9	5.4-9.9	71	5.4
S7	10-61	10-67	15	55	4.3-9.2	4.3-9.2	63	4.3
S8	10-55	10-57	42	46	3.8-8.3	8.3-3.8	56	3.8
S9	10-49	10-52	41	42	3.4-7.5	3.4-7.5	50	3.4
D1	10-46	10-51	divergent	divergent	10.1-14.7	10.1-15.6	divergent	divergent

(3) Positions S1 and S2 are divergent i.e. no focus, beam width increases with working distance. Position S3 produces the most collimated beam

(4) For S4 - S9 positions, working distance range is the range over which intensity is  $\geq 90\%$  of maximum intensity. For S1-S3 positions, working distance range is the range over which intensity is  $\geq 50\%$  of maximum intensity.

(5) For more details on beam width and intensities, see graphs.



## Relative Intensity and Line Thickness vs. Working Distance

### Intensity Versus WD (100 mm Unit) - Red

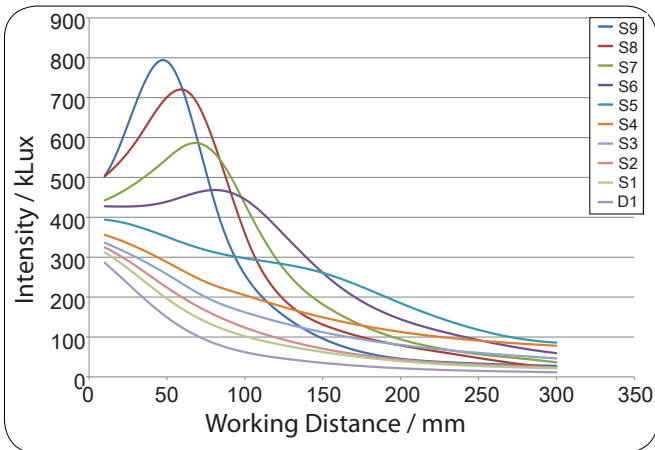

### Intensity Versus WD (300 mm Unit) - Red

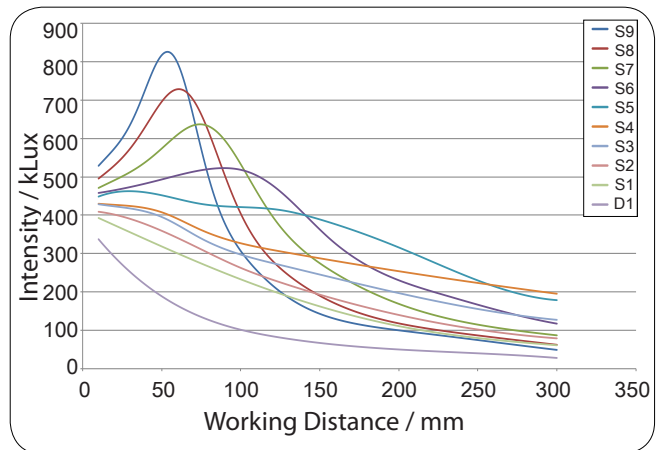

Note: The behavior of Intensity with Working Distance will be similar for units with 3 or more modules

### Line Width Versus Working Distance - Red

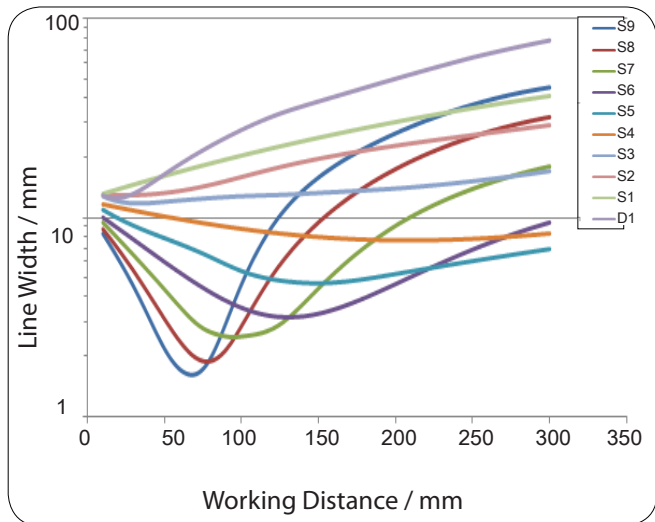

### 60° x 10° Diffuser: (Backlight)

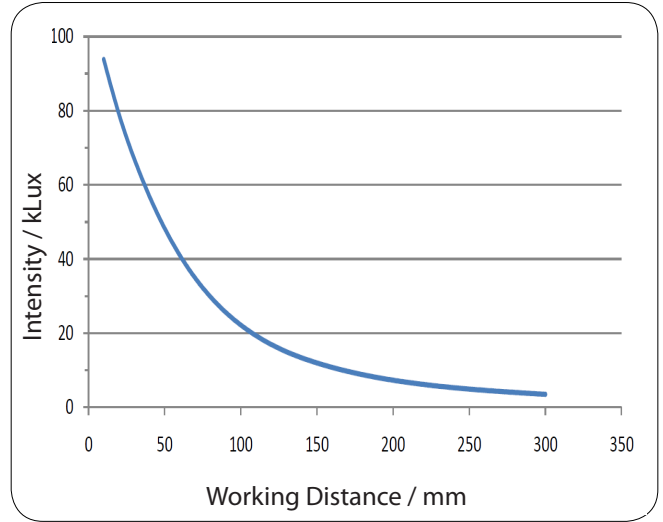

With a diffuser in place the behaviour of intensity with working distance does not vary substantially with lens position or number of units. Therefore the average trend is shown above. However, ProPhotonix recommends lens position, xxx-xxx-xxx-S2-D1 for a backlight configuration.

These graphs show illumination line thickness (FWHM) and intensity in the field of illumination, as a function of working distance. Intensity measurements were taken using a detector with a 9.5 mm diameter aperture. This was factored in for line widths less than 9.5 mm in the Lux calculation.

In the transverse direction, the illumination field has a quasi-gaussian distribution. As mentioned, the line thicknesses shown in the graph are defined as FWHM (full-width-half-maximum). As the working distance is increased, the line thickness increases, with an associated decrease in optical intensity.

Note: The behaviour of Intensity with Working Distance will be similar for units with 3 or more modules.

## Mechanical Dimensions and Mounting

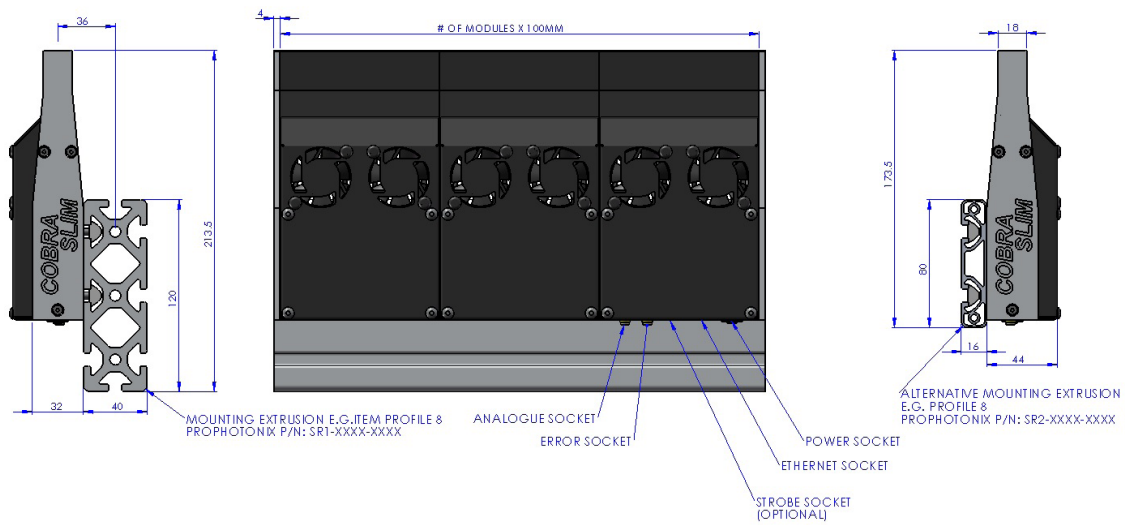

Please ensure there is at least a 3cm gap each side of the units to allow for adequate air flow around the fans.

## LED Lifetime

The LED-based COBRA Slim Illuminators are designed so that, if they are operated at a maximum ambient temperature of 35 °C, the LED lifetime is 50,000 hours. LED lifetime is defined as the time that it takes for optical intensity to drop from its initial value to one half of that initial value. Running the units in environments having temperatures higher than 35 °C will result in the accelerated aging of the LED sources or will cause the light to shut down due to over temperature condition detected.

## Cleaning or Replacing Fans

The fans are reliable, long lasting and the MTBF is 47,500 hours at 40 °C. For instructions on how to clean the fans, please contact ProPhotonix. Please note that we sell replacement fans and provide instructions on how to install them.

## Cleaning or Replacing Optical Windows

For instructions on how to clean the optical window, please contact ProPhotonix. Please note that we sell replacement windows and provide instructions on how to install them.

## Warranty

Do not attempt to disassemble your COBRA Slim Illuminator before contacting ProPhotonix. Any such action will void the warranty.

COBRA Slim Illuminators and accessories are guaranteed by ProPhotonix to be free from material and manufacturing defects for standard warranty period from the date of shipment. Should a product fail during this period, ProPhotonix will, at its discretion, either repair or replace the damaged unit. Repaired units or replacement units will be covered for the remainder of the original warranty period. The warranty does not apply to units that have failed due to abuse, acts of God, mishandling, alteration, improper installation, or negligence.

## Ordering and Part Numbers

### Part Number Structure

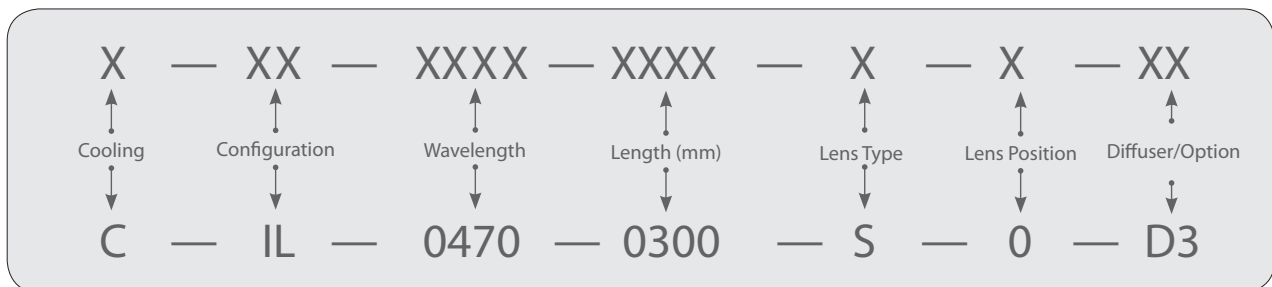

## Part Number Options

Cooling		Configuration		Standard Wavelengths (nm)		Length (mm)	Lens Type <sup>(6)</sup>		Lens Position		Diffuser or Options	
C	Convection	IL	Error output & analogue control	0365	UV	0100	S	Standard	0	No Lens	D0	No Diffuser
T	Fan	EL	IL Options + Ethernet Connector	0395	UV	↓	R	Custom Optics for Broad Illumination	1	Closest to LEDs	D1	60:10 (Backlight)
		AL	EL Options + Strobe Capability	0470	Blue	0900	M	Extra Internal Micro-lens	↓	Furthest from LEDs	D2	30:1
				0630	Red	1000			9		D3	To Be Defined
				0870	Near-IR	1100					↓	
				0000	White	↓					D9	Additional Focusing Lens Option
				0RGB	Red, Green & Blue	↓					F1-9	
						6000						

365-1500 nm custom wavelengths available

(6) Non-standard lenses are also available on request

Products	Part Number
240 Watts Power Supply	PSU-24V-240W-XX*

\*Add Country or Region signifier to the part number as per following table

## Plug Type Part Numbers

Country or Region	Signifier
Europe	EU
United Kingdom, Singapore, Malaysia	UK
Israel	IL
North America / Japan	US
No Plug	X

## COBRA Slim Accessory Part Numbers

Accessories: Power Supplies and External Control Unit	Stand Alone Part Number
Additional power supply cable 100cm-500cm straight connector	C2-CAB-P-S-XXXX (XXXX=Length in CM)
Additional power supply cable 100cm-500cm right angle connector	C2-CAB-P-R-XXXX (XXXX=Length in CM)

For more information contact us at [sales@prophotonix.com](mailto:sales@prophotonix.com) or visit us at [www.prophotonix.com](http://www.prophotonix.com)

#### LED Solutions

3020 Euro Business Park, Little Island  
Cork, Ireland  
Tel: +353-21-5001300

#### Lasers Solutions

Sparrow Lane, Hatfield Broad Oak  
Hertfordshire, CM22 7BA, UK  
Tel: +44-1279-717170

#### North/South America Sales

32 Hampshire Road  
Salem, NH03079  
Tel: +1 800-472-4633



ProPhotonix and the ProPhotonix logo are trademarks of ProPhotonix Ltd. All other brand and product names are trademarks or registered trademarks of their respective holders. Copyright © 2012 ProPhotonix Ltd. All rights reserved.